

POWERSUPPLIES

DC to AC inverter, 1500W pure sine wave



- Pure sine wave output
- High peak power output
- Over load, polarity and short circuit protection
- CE marking including LVD
- Equipped with remote function input

Technical data:

Input:

Input voltage: 12VDC or 24VDC
 Input voltage tolerance: 10-16VDC or 20-32VDC
 Current consumption at no load: 1.3A at 12V and 0.7A at 24V

Output:

Output voltage: 230VAC/50Hz pure sine wave
 Regulation: +/-5%
 Output power nominal: 1500W continuous
 Output power peak: 3000W for 100mS
 Efficiency: >85%
 Protection: Short circuit, Overload and polarity protection (fuse)
 Temperature protection: Shutdown at 60°C +/-10°C
 High battery voltage: Shutdown at 15V, +/-0.5V or 32V, +/- 1.0V
 Alarm at 10.5V, +/-0.5V or 21V, +/- 1.0V
 Low battery voltage: Shutdown at 10V, +/-0.5V or 20V, +/- 1.0V

Fuse: 40A@12V (6 pcs) / 20A@24V (6 pcs)
 Temperature range: -20°C+60°C
 Cooling: Fan inside
 Size: 420x223x101 mm
 Weight: 6200g
 Safety and EMC: CE / LVD acc. to EN60950

Mechanical drawing:

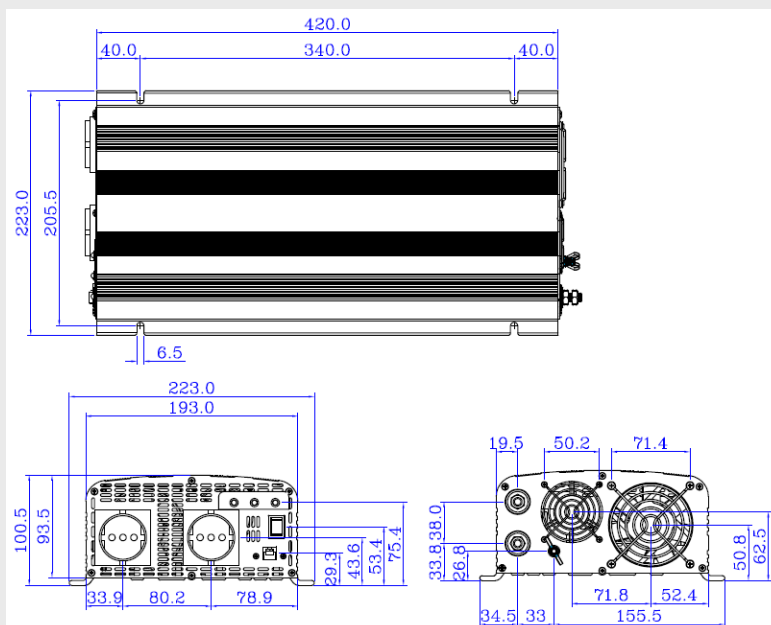

Ordering information:

Type	Input voltage	Power	Output voltage
INT-1500/12-230	12VDC	1500W	230VAC
INT-1500/24-230	24VDC	1500W	230VAC
REMOTE 2	Remote with 6m cable		